

SFB 1245 Workshop 2017  
Mainz, 05.10.2017  
Julian Kahlbow for TP A06  
PI: T. Aumann, D. Rossi



TECHNISCHE  
UNIVERSITÄT  
DARMSTADT

# Neutron-unbound States at the low-Z Shore of the Island of Inversion



# The “Island of Inversion“

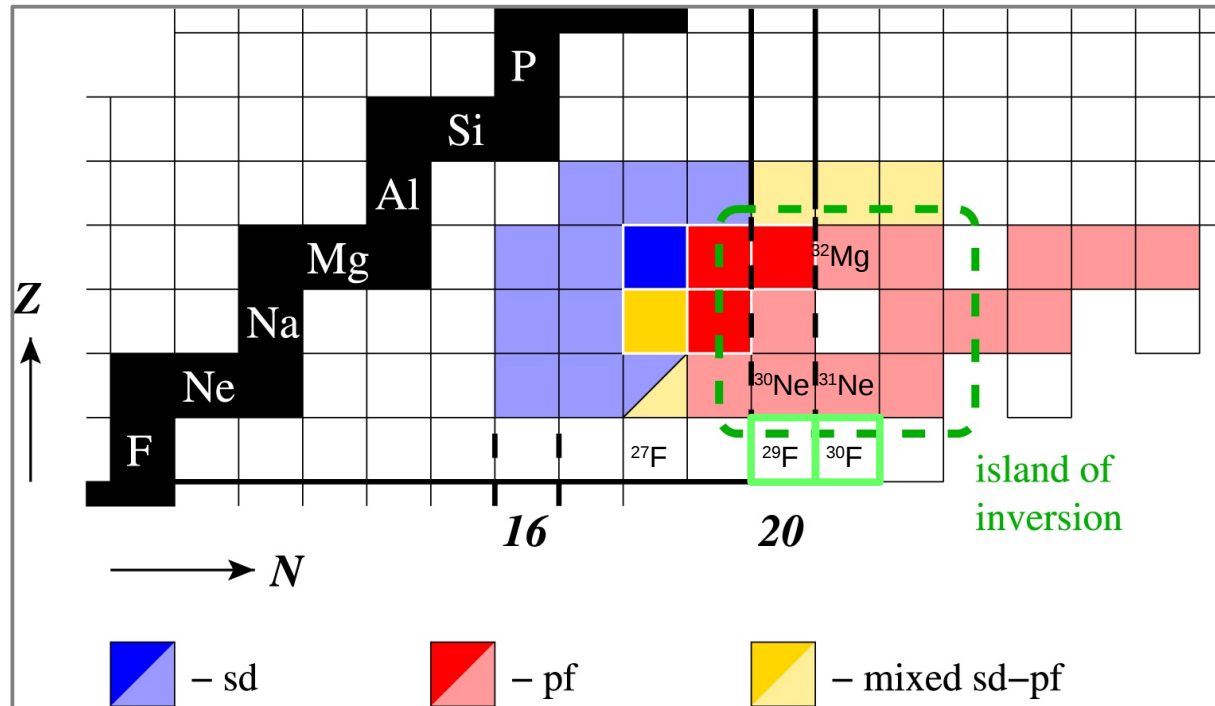

P.A. Butler et al., J. Phys. G: Nucl. Part. Phys. 44 (2017)

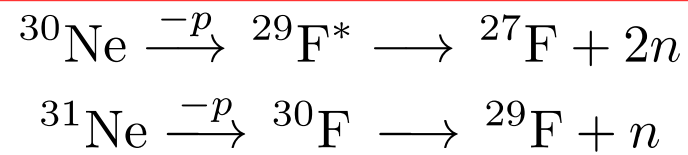

# What is known about $^{30}\text{F}$ ?

H. Sakurai et al., Phys. Lett. B 448 (1999)

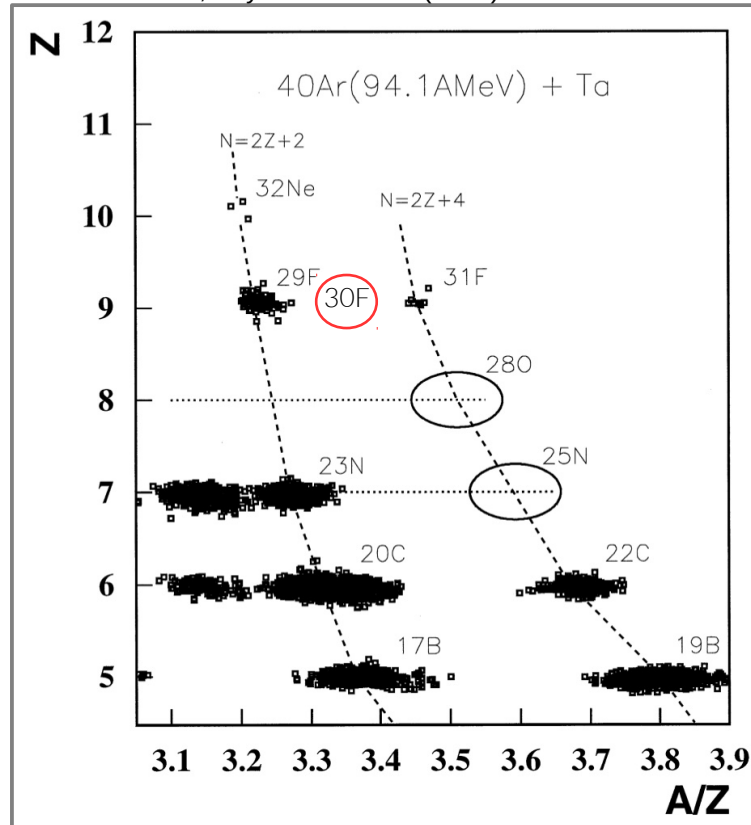

## ADOPTED LEVELS for $^{30}\text{F}$

Author: M. SHAMSUZZOHA BASUNIA Citation: Nuclear Data Sheets 111, 2331 (2010)

[Full ENSDF file](#)

$Q(\beta^-) = 2.51\text{E}4 \text{ keV SY}$   $S_n = -4.\text{E}2 \text{ keV SY}$

$E_{\text{level}}$ (keV)	$T_{1/2}$
0.0	% n = ?

NNDC 2017

$^{30}\text{F}$  is neutron-unbound ... that's it

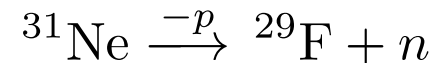

TP A04: Shell model interactions from Chiral Effective Field Theory could provide predictions?

# What is known about $^{29}\text{F}$ ?

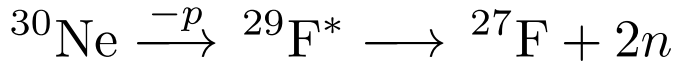

$^9\text{Be}(^{29}\text{Ne}, ^{28}\text{F}) @ \text{NSCL}$

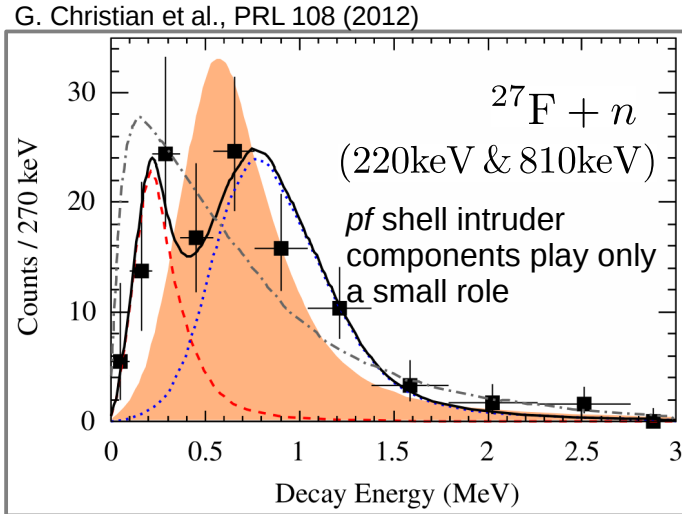

## In-beam gamma spectroscopy $\text{CH}_2/\text{C}(^{30}\text{Ne}, ^{29,27}\text{F})$

P. Doornenbal et al., Phys. Rev. C 95 (2017)

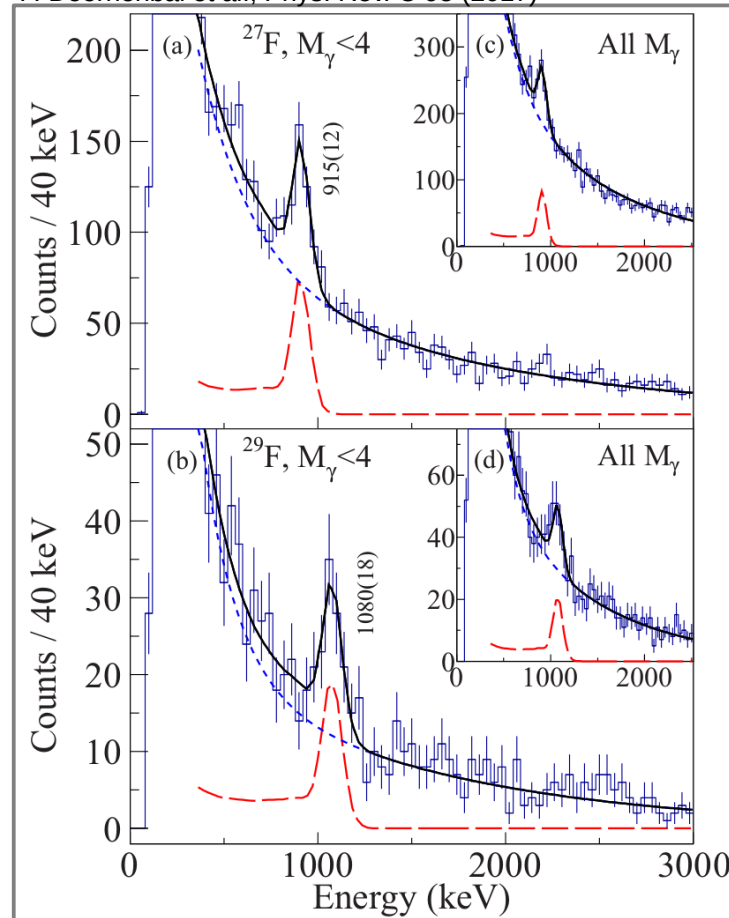

& 504(15)keV,  
777(19)keV

Z. Elekes et al.,  
Phys. Lett. B 599 (2004)

$1/2^+$  exc. state  
(only bound  
excited state?)

# The low-Z shore of the “Island of Inversion”

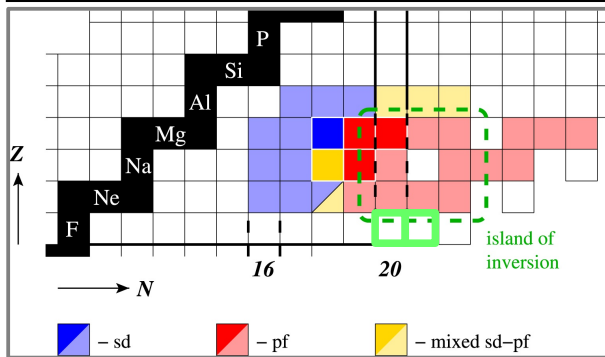

P.A. Butler et al., J. Phys. G: Nucl. Part. Phys. 44 (2017)

P. Doornenbal et al., Phys. Rev. C 95 (2017)

- Interplay:  
heaviest O isotopes ↔ F isotopes ↔ Island of Inversion  
2p2h & 4p4h *pf*-shell configurations are crucial
- neutron-unbound states provide more complete picture  
(also *f* & *p* wave access)

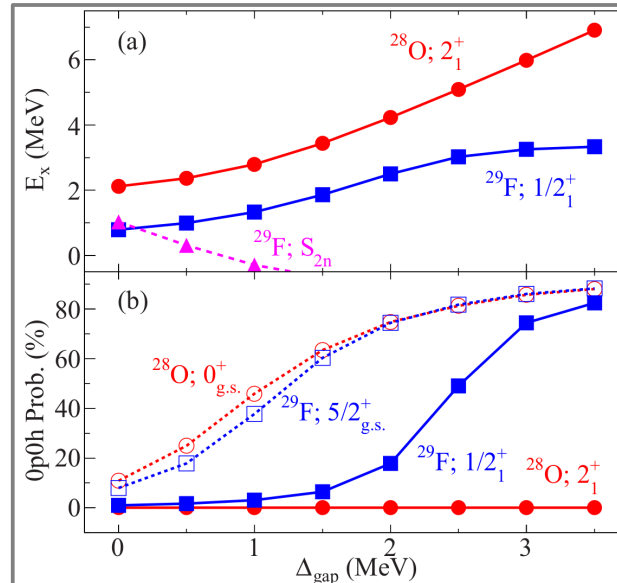
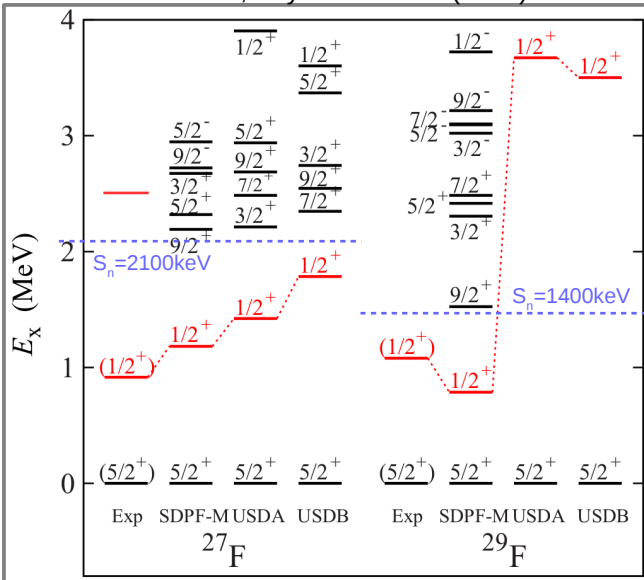

Y. Utsuno et al., Phys. Rev. C 60 (1999)

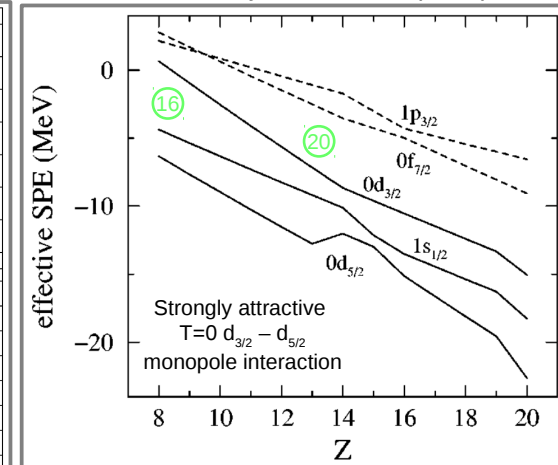

# Spectroscopy of neutron-rich Oxygen Isotopes at the RI Beam Factory

Spokesperson: Y. Kondo (Tokyo Inst. of Technology)

“Spectroscopy of  $^{27}\text{O}$  &  $^{28}\text{O}$ “

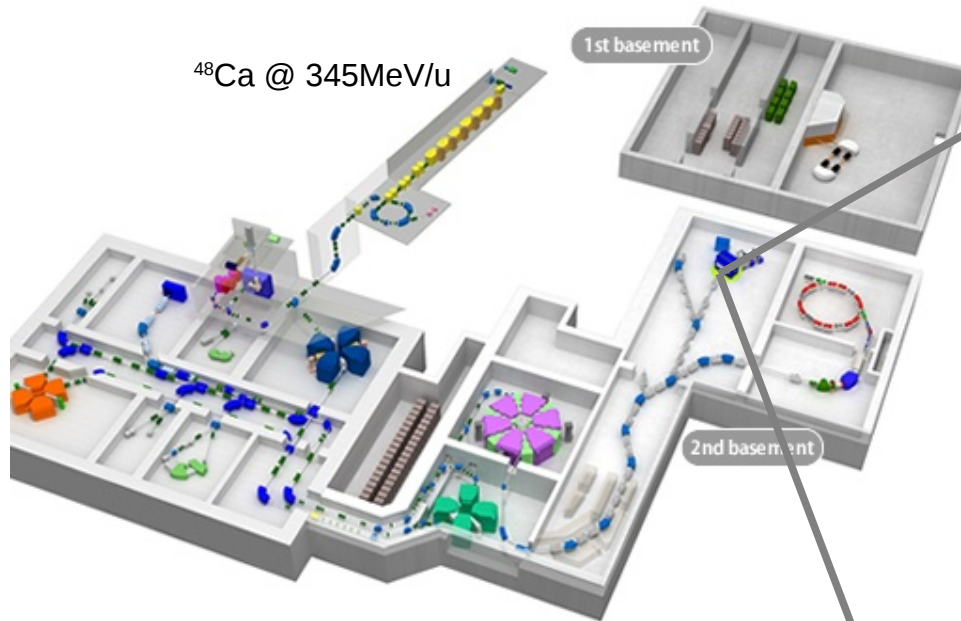
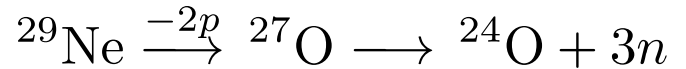
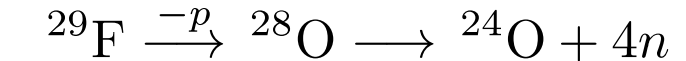

Kinematically complete measurements with radioactive beams in inverse kinematics at high energies

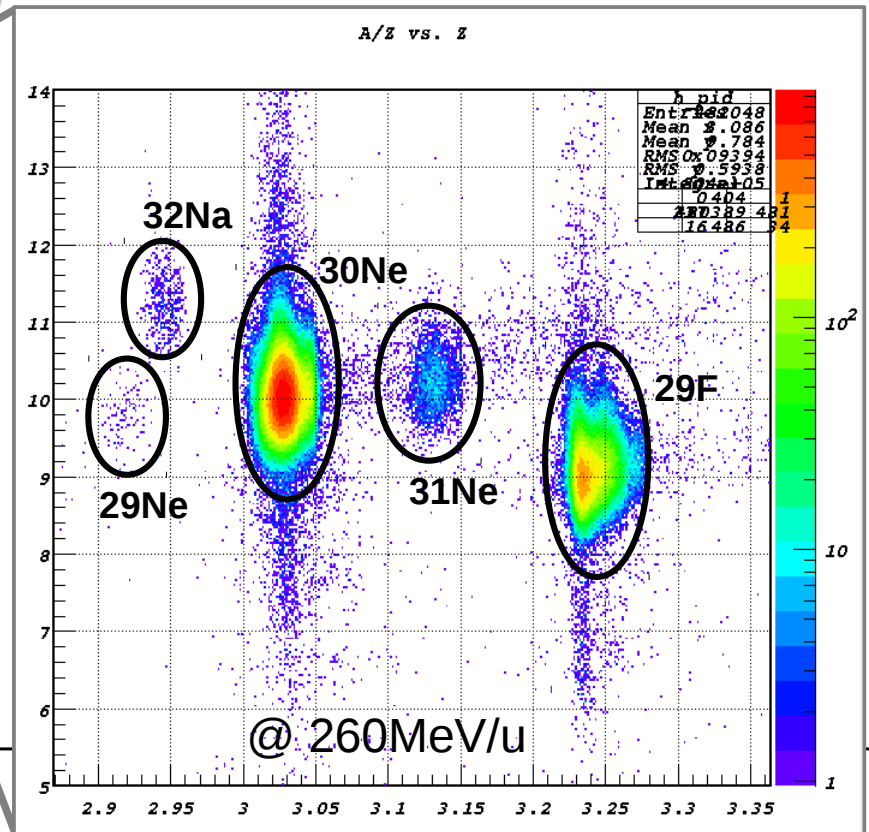

# SAMURAI Experimental Setup

Superconducting **A**nalyzer for **M**ulti-particles from **R**adio **I**sotope **B**eams

(SAMURAI + MINOS + DALI2 + NeuLAND)



TECHNISCHE  
UNIVERSITÄT  
DARMSTADT

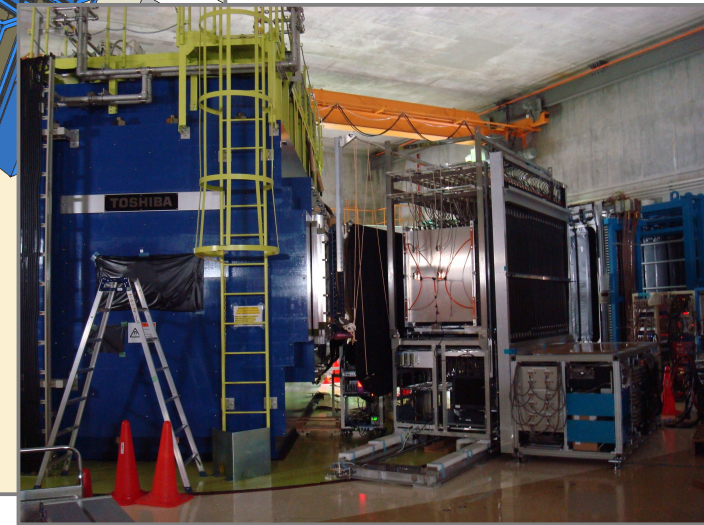
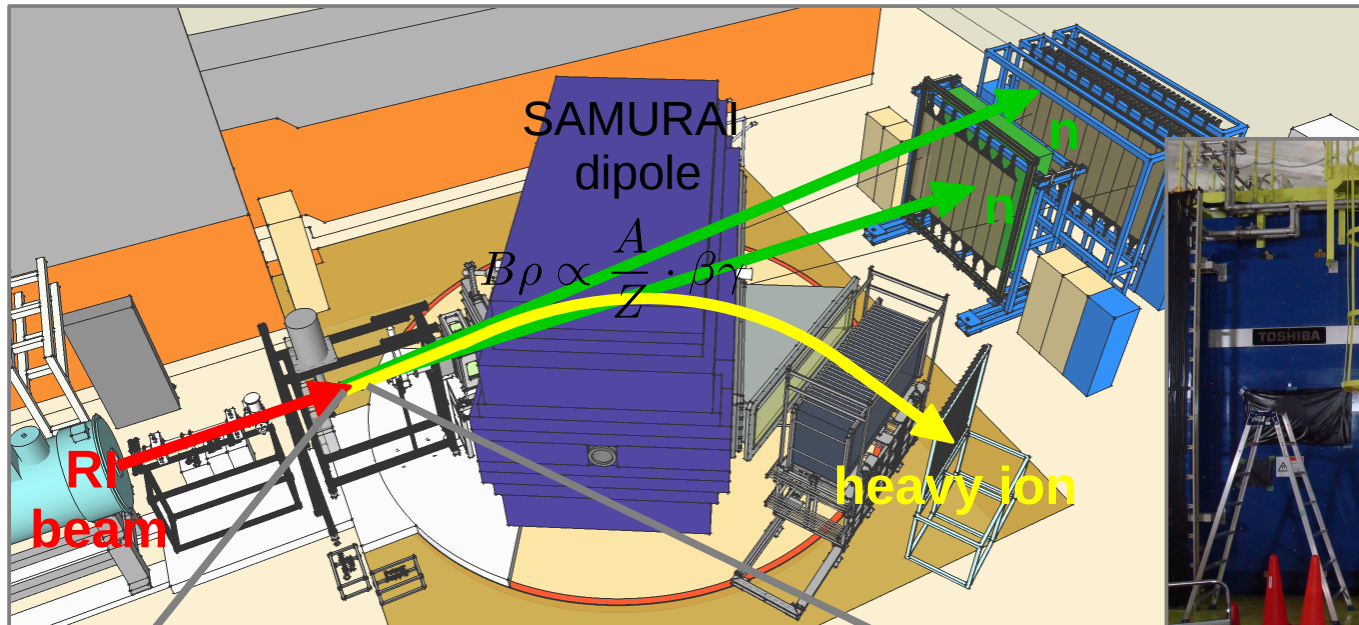

MINOS

Liquid H<sub>2</sub> target + Vertex Tracker

- high luminosity
- good vertex pos. resolution for (p,2p)

A. Obertelli et al., Eur. Phys. J. A 50 (2014)

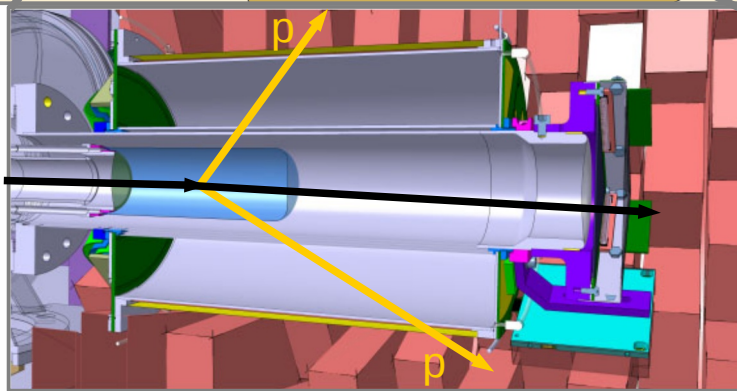

# Oxygen Anomaly

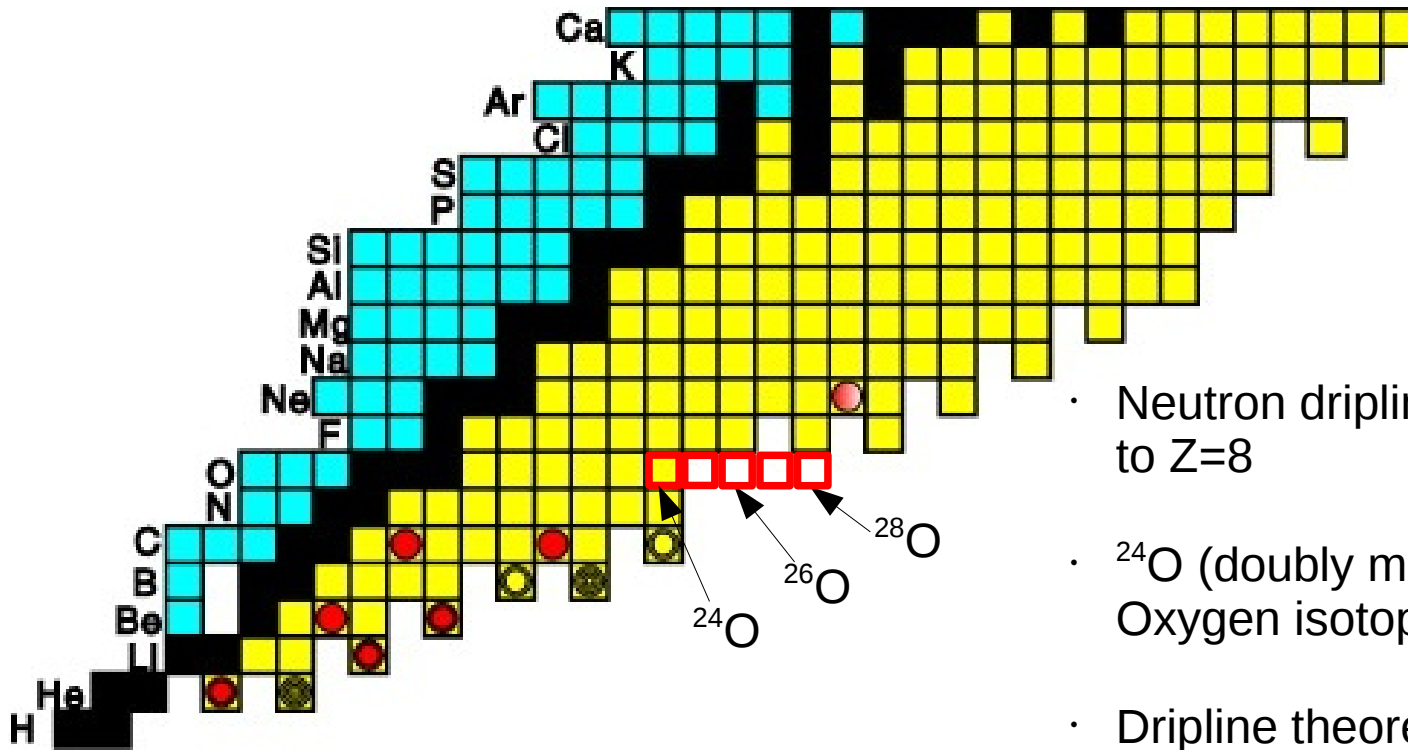

- Neutron dripline exp. known up to  $Z=8$
- $^{24}\text{O}$  (doubly magic) is last bound Oxygen isotope
- Dripline theoretically reproduced only by including  $3N$  forces
- $^{26}\text{O}$  is true  $2n$  emitter



# $^{26}\text{O}$ – A barely unbound system

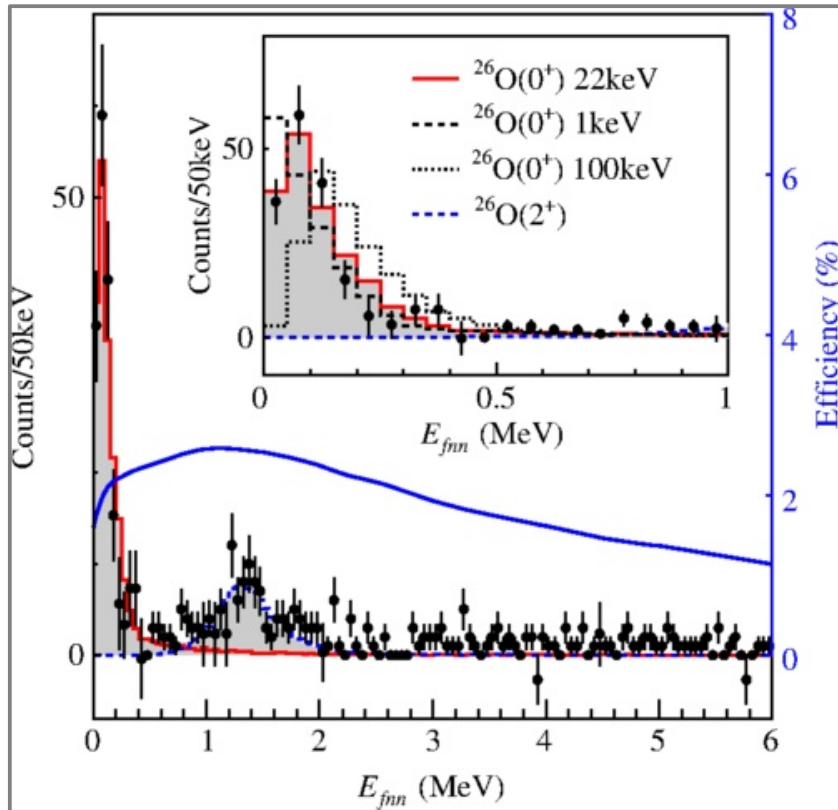

## RIBF Experiment (Japan)

$$E_r = 18 \pm 3(\text{stat}) \pm 4(\text{syst}) \text{ keV}$$

$$E_r(2^+) = 1.28^{+0.11}_{-0.08} \text{ MeV}$$

## $^{26}\text{O}$ – A neutron-radioactive Nucleus?

- Predictions by L. Grigorenko et al. (PRL 111 (4) (2013) 042501) :  
Angular barrier of  $d$  wave valence neutrons could cause lifetime in ps range

- Measurement at NSCL

(Z. Kohley et al., PRL 110, 152501 (2013)):

$$\tau = 6.5^{+1.6}_{-2.2}(\text{stat}) \pm 4.3(\text{syst}) \text{ ps}$$

# $^{26}\text{O}$ – A neutron-radioactive Nucleus? A new and precise method

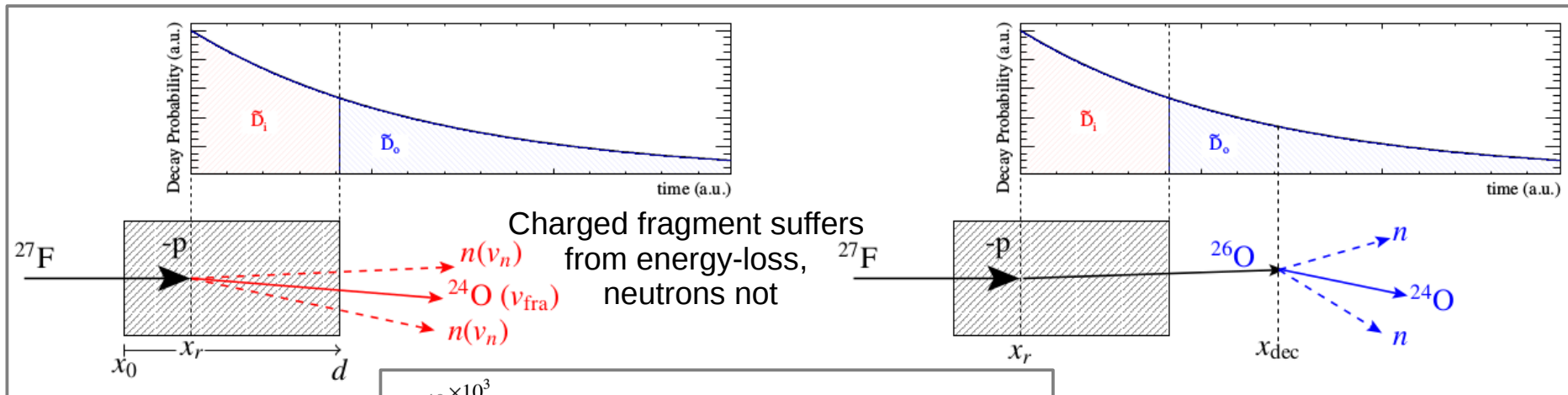

→ Lifetime from ratio of decays in the target to decays outside the target  
( $\Delta v = v_n - v_{fra}$ )

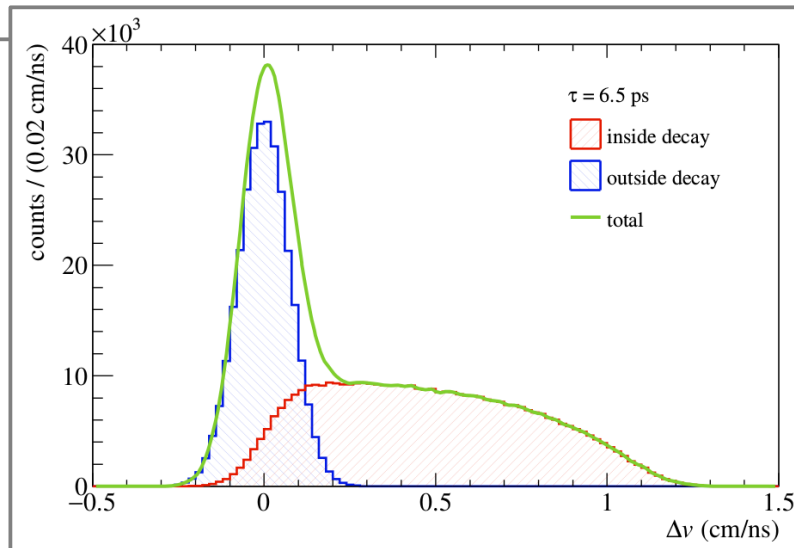

Simulation results optimised for

- lifetime,
- target thickness,
- target material,
- beam energy

JK, C. Caesar et al., NIM A 866, 265 (2017)

# $^{26}\text{O}$ – A neutron-radioactive Nucleus? A new and precise method

And using several targets ...

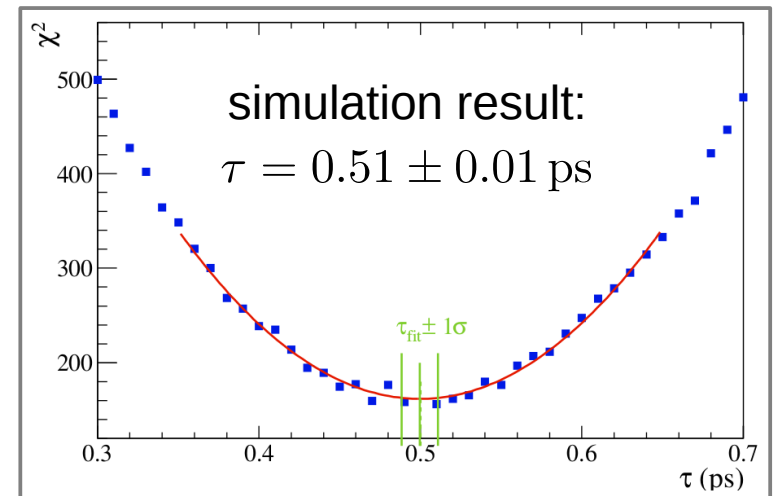
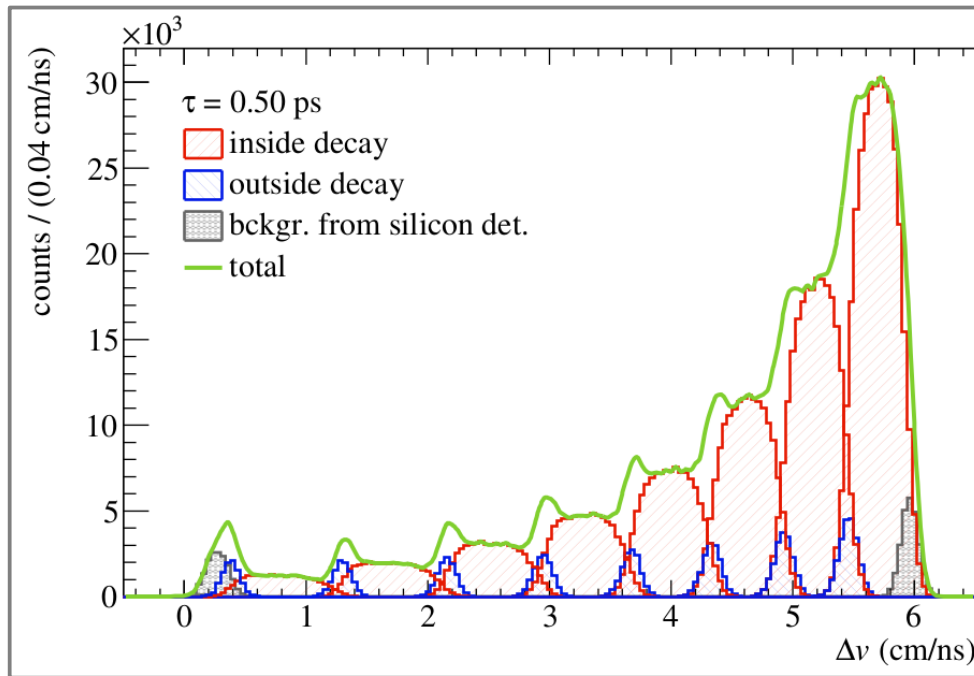

→ the experiment has been performed in Dec. 2016 at SAMURAI (C. Caesar)

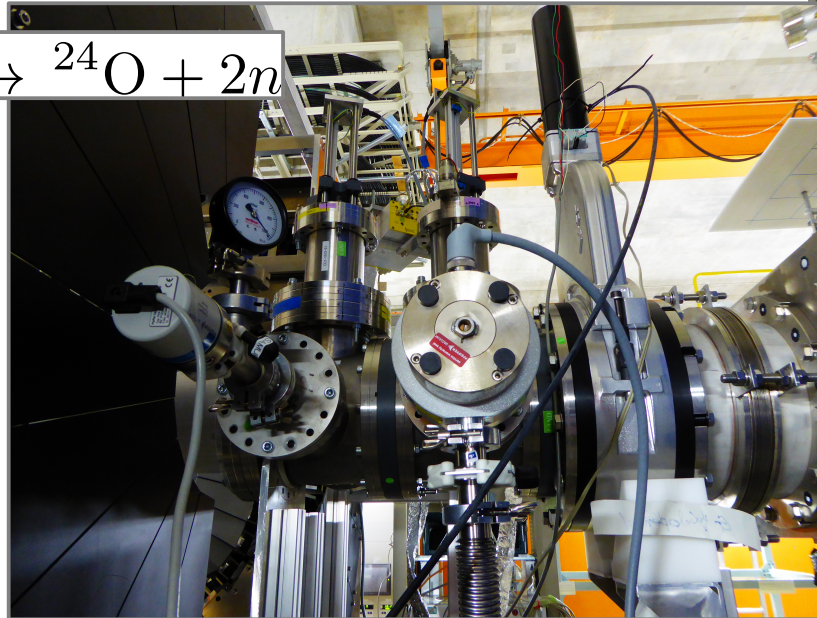
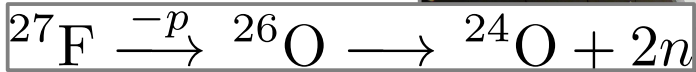
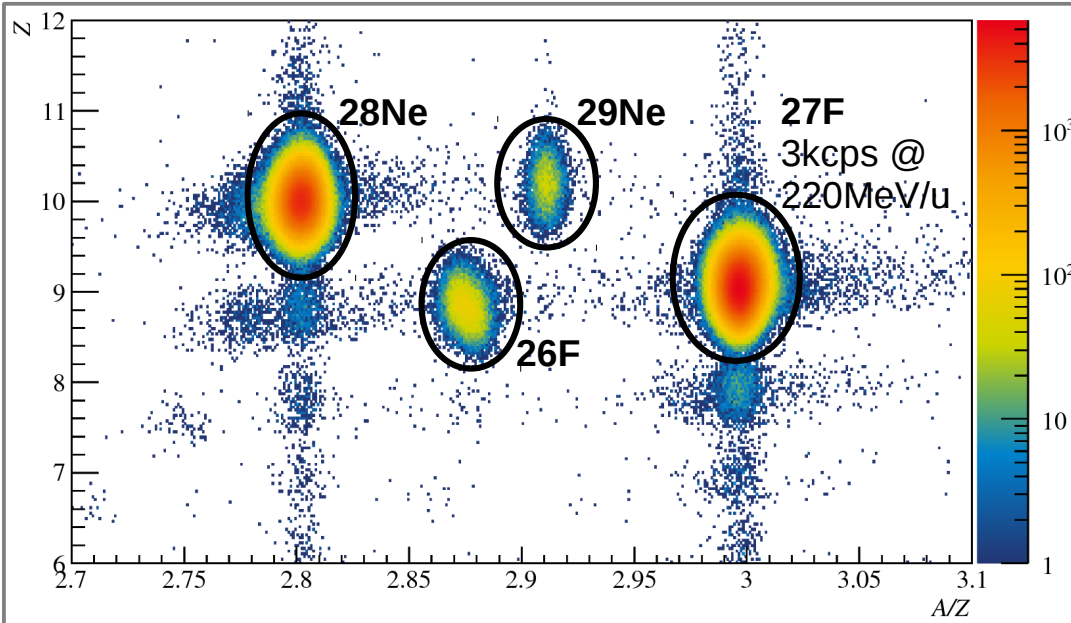

4 x W + 2 x Pt targets:  
14.6g/cm<sup>2</sup>

# Summary

**We have recently finished a 2-year experimental campaign at the RIKEN Nishina Center:**

## TP A06

- $^{29}\text{F} \xrightarrow{-p} ^{28}\text{O}^* \longrightarrow ^{24}\text{O} + 4n$
- Ground-state Lifetime of  $^{26}\text{O}$
- "Tetraneutron" (F. Schindler)

## TP A05

- "Soft Dipole  $^{6,8}\text{He}$ " (C. Lehr)
- Coulomb Break-up of  $^{31}\text{Ne}$

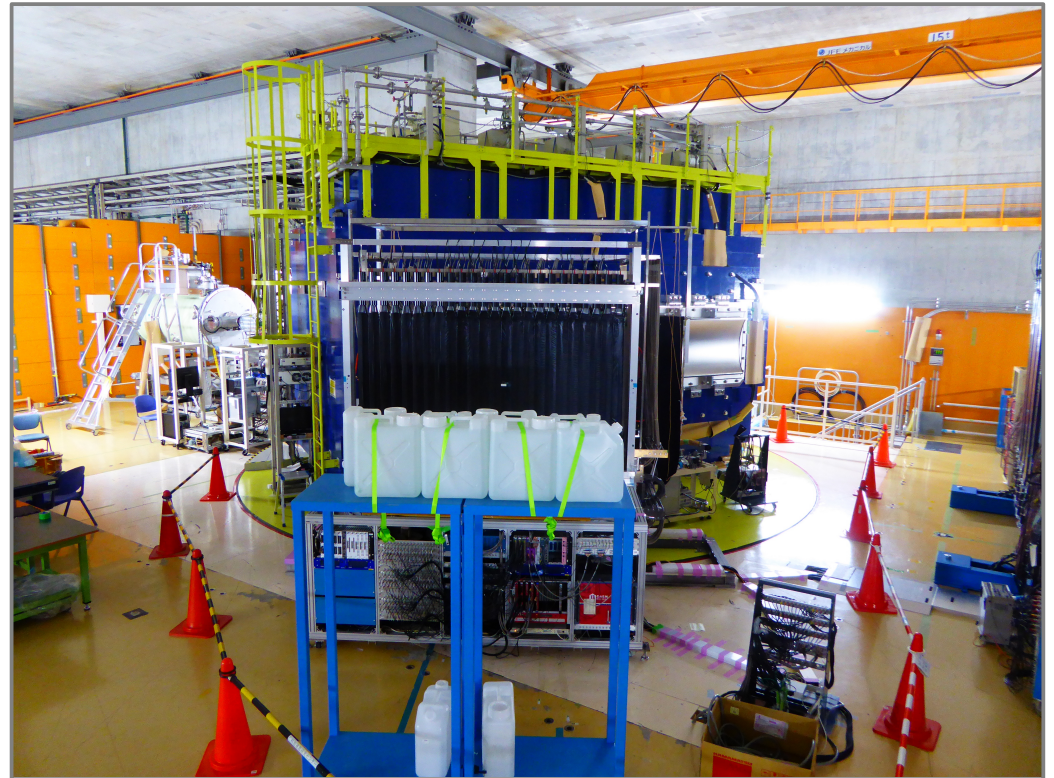

---

# Thank You for Your Attention.

---



TECHNISCHE  
UNIVERSITÄT  
DARMSTADT

**Y.Kondo** N.L.Achouri H.Al Falou L.Atar T.Aumann H.Baba K.Boretzky C.Caesar D.Calvet H.Chae N.Chiga A.Corsi H.L.Crawford F.Delaunay A.Delbart Q.Deshayes Zs.Dombrádi C.Douma Z.Elekes P.Fallon I.Gašparić J.-M.Gheller J.Gibelin A.Gillibert M.N.Harakeh A.Hirayama C.R.Hoffman M.Holl A.Horvat Á.Horváth J.W.Hwang T.Isobe J.Kahlbow N.Kalantar-Nayestanaki S.Kawase S.Kim K.Kisamori T.Kobayashi D.Körper S.Koyama I.Kuti V.Lapoux S.Lindberg F.M.Marqués S.Masuoka J.Mayer K.Miki T.Murakami M.A.Najafi T.Nakamura K.Nakano N.Nakatsuka T.Nilsson A.Obertelli F.de Oliveira Santos N.A.Orr H.Otsu T.Ozaki V.Panin S.Paschalis A.Revel D.Rossi A.T.Saito T.Saito M.Sasano H.Sato Y.Satou H.Scheit F.Schindler P.Schrock M.Shikata Y.Shimizu H.Simon D.Sohler O.Sorlin L.Stuhl S.Takeuchi M.Tanaka M.Thoennessen H.Törnqvist Y.Togano T.Tomai J.Tscheuschner J.Tsubota T.Uesaka H.Wang Z.Yang K.Yoneda **for the SAMURAI21 Collaboration**

**C.Caesar J.Kahlbow** V.Panin D.S.Ahn L.Atar T.Aumann H.Baba K.Boretzky H.Chae N.Chiga S.Choi M.L.Cortes Sua D.Cortina-Gil Q.Deshayes P.Doornenbal Z.Elekes N.Fukuda I.Gasparic K.I.Hahn Z.Halasz A.Hirayama J.Hwang N.Inabe T.Isobe S.Kim T.Kobayashi D.Körper Y.Kondo Y.Kubota I.Kuti C.Lehr S.Lindberg M.Marques M.Matsumoto T.Murakami I.Murray T.Nakamura T.Nilsson H.Otsu S.Paschalis M.Parlog M.Petri D.Rossi A.Saito M.Sasano H.Scheit P.Schrock Y.Shimizu H.Simon D.Sohler S.Storck L.Stuhl H.Suzuki I.Syndikus H.Takeda H.Törnqvist T.Togano T.Tomai T.Uesaka H.Yamada Z.Yang M.Yasuda K.I.Yoneda **for the SAMURAI20 Collaboration**